

250 to 2100 Watt, Linear Accuracy High Performance Power Supplies SRL Series

The SRL Series programmable laboratory and industrial supplies add preregulation to linear series pass design to give high efficiency and outstanding performance with low rms ripple and p-p noise. Voltage ranges of 14 models are from 0-10 Vdc to 0-60 Vdc with power levels from 250 to 2100 W.

- 14 models in voltage ranges from 0-10 Vdc to 0-60 Vdc with power levels from 250 to 2100 watts
- 115/208/230 Vac single phase input available on all models except SRL 40-50 and SRL 60-35 which are 208/230 Vac single phase only
- 50/60 Hz operation without derating
- SCR preregulation and linear series pass design provide high efficiency and performance
- Remote voltage or resistance programming in voltage or current modes
- Excellent voltage or current regulation with automatic crossover
- Unique quick set and check of built-in over-voltage protection can be monitored and adjusted on front panel. Set point can be adjusted without removing load or ac power
- No overshoot at turn-on, turn-off or power failure
- 0.01% line and load regulation or 2 mV, 200-700 μ V rms ripple
- 150 μ s transient response—100% change (typical)
- Option M50: LCD digital panel meters
- 5-year warranty

Toll Free: 1-800-525-2024

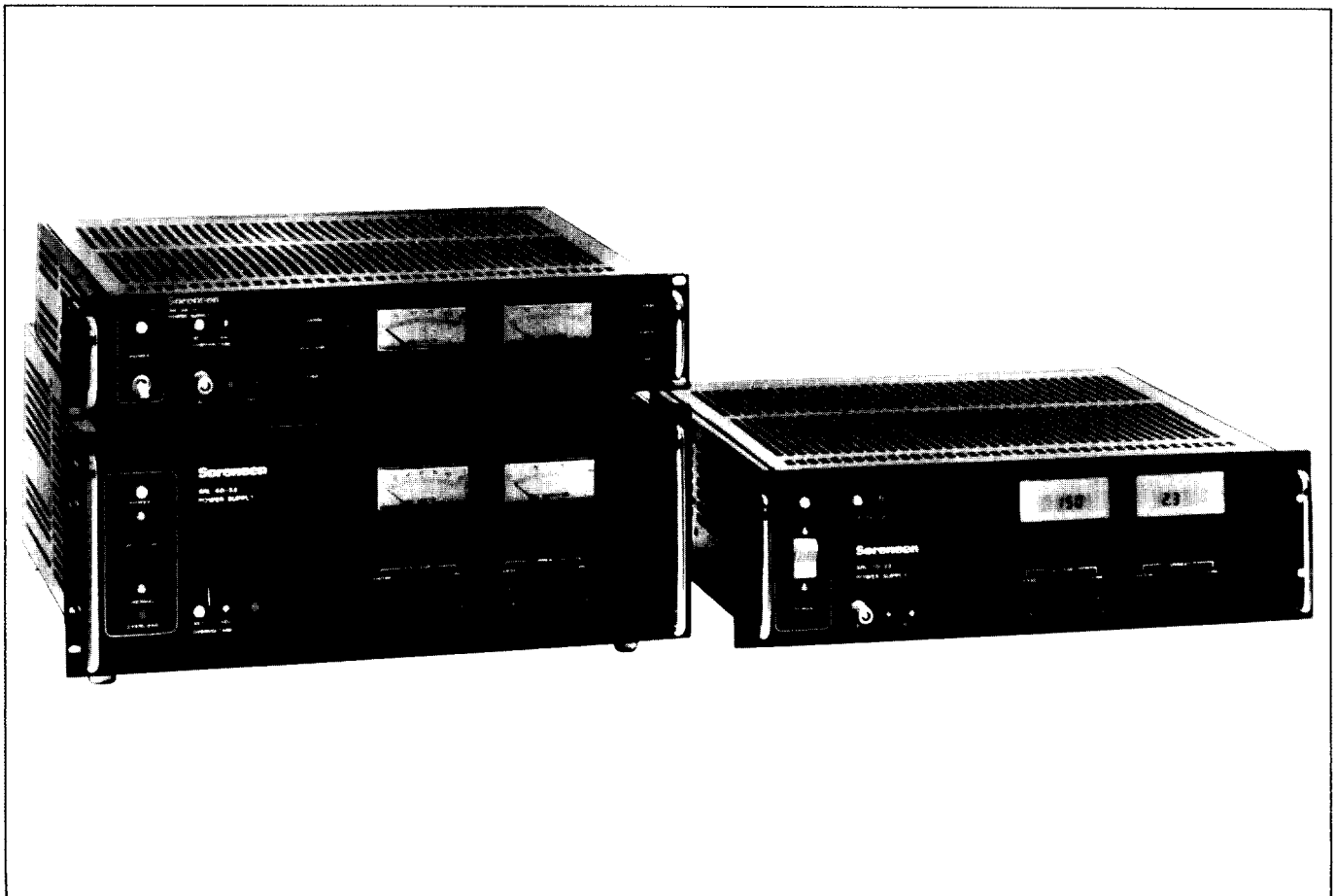

DC OUTPUT

CONSTANT VOLTAGE MODE

Voltage Regulation:

Line and load combined:
.01% or 2 mV, whichever is greater

Temperature Coefficient:

0.01% + 0.2 mV/°C.

Resistance Programming:

200 ohms per volt standard;
(adjustable to 1000 ohms per volt
through the use of externally added
components).

Voltage Programming:

1 Volt per volt standard.

Stability:

0.025% + 0.5 mV for 8 hours after 30
minute warm-up time with constant
line, load and operating
temperature.

Ripple: 200 to 700 μ V rms.

Remote Sensing:

1 V maximum drop per load lead
(rear terminal connection).

Transient Response:

150 μ s (typical) to return to a
bandwidth of ± 10 mV for step load
change of 0 to 100% of full load.

CONSTANT CURRENT MODE

Current Programming:

1000 ohms programs full rated
output.

Ripple: 0.5 to 10 mA rms.

Voltage Signal Programming:

Consult factory or operating
manual.

Current Regulation:

0.02% + 6 mA line or load.

Minimum Current:

Adjustable down to zero.

Temperature Coefficient:

0.01% + 2 mA per °C.

Stability:

0.03% + 10 mA (typical for 8 hours
after 30 minute warm-up time with
constant line, load, and ambient
operating temperature).

AC INPUT

Voltage:

105-125 Vac single phase (SRL 40-
50 and SRL 60-35, 190-230 Vac
single phase).

Voltage Options:

See table; consult factory for
price.

Frequency:

47-63 Hz without derating.

Model	Output Power				Constant Voltage Mode					Temp. Coeff., Voltage .01% \pm μ V (Δ / °C)	Voltage Drift, (Typ.) ³ .025% \pm μ V	Programming Constants Voltage Mode ⁴	
	Voltage (Vdc)	Current (A dc)			Regulation ¹ .01% or _ mV	Ripple (PAR), μ V		Resolution mV (Typ.)	Transient Response ² Time (Typ.) μ s			Ohms (\pm .5%) /V	V/V
		55°C	60°C	71°C		rms (10 Hz to 7 MHz)	P-P (7 Hz to 25 MHz)						
SRL 10-25	0-10	25	22	16.7	2	350	20	5	150	200	500	200	1
SRL 10-50	0-10	50	44	33.5	2	300	10	1	150	200	500	200	1
SRL 10-100	0-10	100	88	67	2	300	20	5	150	200	500	200	1
SRL 20-12	0-20	12	10.5	8	2	200	20	2	70	200	500	200	1
SRL 20-25	0-20	25	22	16.7	2	300	20	5	150	200	500	200	1
SRL 20-50	0-20	50	44	33.5	2	500	40	5	150	200	500	200	1
SRL 40-6	0-40	6	5.3	4	2	200	20	4	70	200	500	200	1
SRL 40-12	0-40	12	10.5	8	2	300	20	5	150	200	500	200	1
SRL 40-25	0-40	25	22	16.7	2	500	10	4	150	200	500	200	1
SRL 40-50	0-40	50	44	33.5	2	700	40	5	150	200	500	200	1
SRL 60-4	0-60	4	3.5	2.68	2	300	20	6	70	200	500	200	1
SRL 60-8	0-60	8	7	5.36	2	300	20	5	70	200	500	200	1
SRL 60-17	0-60	17	14.9	11.4	2	500	10	6	150	200	500	200	1
SRL 60-35	0-60	35	31	23.4	2	700	40	5	150	200	500	200	1

SRL Series Specifications

OPERATING DATA
Ambient Operating Temperature Range:
 0 to + 70°C.

Storage Temperature Range:
 - 40°C to +85°C.

Series Operation:
 200 Vdc maximum.

Parallel Operation:
 Master-slave or straight parallel; 3 units maximum in master slave.

RFI:
 MIL-I-6181D

Automatic Crossover:
 Automatic between voltage and current modes.

Overvoltage Protection:
 Built-in adjustable crowbar, 10 μ s operation. May be checked or adjusted from front panel without removing ac power or load.

SRL ACCESSORIES
Chassis Slides (Kit):
 Available for convection-cooled models. See dimensional drawings.

Digital Programmer:
 Available for all models in SRL series. IEEE 488 interface to GPIB Bus. Refer to page 61.

OPTIONS
M50—LCD digital panel meters

INPUT VOLTAGE OPTIONS

Model	Option ¹	Input Power ²		Model	Option ¹	Input Power ²	
		Vac	Aac			Vac	Aac
SRL 10-25	M1	190-230	4.1	SRL 40-12	M1	190-230	7.3
	M2	210-250	3.75		M2	210-250	6.6
SRL 10-50	M1	190-230	8.0	SRL 40-25	M1	190-230	12.3
	M2	210-250	7.3		M2	210-250	11.0
SRL 10-100	M1	190-230	18.5	SRL 40-50	M2	210-250	23.0
	M2	210-250	16.3				
SRL 20-12	M1	190-230	4.3	SRL 60-4	M1	190-230	3.3
	M2	210-250	3.9		M2	210-250	3.0
SRL 20-25	M1	190-230	7.5	SRL 60-8	M1	190-230	6.9
	M2	210-250	6.8		M2	210-250	6.25
SRL 20-50	M1	190-230	15.4	SRL 60-17	M1	190-230	12.0
	M2	210-250	14.0		M2	210-250	11.0
SRL 40-6	M1	190-230	3.5	SRL 60-35	M2	210-250	24.0
	M2	210-250	3.2				

NOTES: 1. To specify optional power input, add option suffix to part number.
 2. Single phase, 47-53/57-63 Hz.

Model	Constant Current Mode			Temp. Coeff., Current .01% \pm mA (Δ / °C)	Current Drift, (Typ.) ³ .03% \pm mA	Programming Constants Current Mode		Standard Input Power (single phase, 47-53/57-63 Hz)		Power Factor (Typ.)	Cooling	Case Size
	Regulation ¹ .02% + _ mA	Ripple ⁵ (PARD)				Ohms (\pm 10%)/A	mV/A	(Vac)	Aac (Max.)			
		mA rms (10 Hz to 7 MHz)	Resolution mA (Typ.)									
SRL 10-25	4	10	3.75	1	3	40	20	105-125	7.5	0.67	Convection	II
SRL 10-50	4	20	7.5	1	3	20	8	105-125	14.7	0.73	Fan	II
SRL 10-100	6	30	15	2	10	10	2.5	105-125	32.5	0.66	Fan	III
SRL 20-12	4	3	1.8	1	3	80	80	105-125	7.8	0.65	Convection	I
SRL 20-25	4	10	3.75	1	3	40	20	105-125	13.6	0.64	Convection	II
SRL 20-50	4	10	7.5	1	3	20	8	105-125	28.0	0.64	Fan	III
SRL 40-6	1	0.5	0.9	0.5	3	150	150	105-125	6.3	0.58	Convection	I
SRL 40-12	4	1	1.8	1	3	80	80	105-125	13.2	0.56	Convection	II
SRL 40-25	4	10	3.75	1	3	40	20	105-125	22.0	0.675	Fan	II
SRL 40-50	4	10	7.5	1	3	20	8	190-230	25.0	0.66	Fan	III
SRL 60-4	1	0.5	0.6	0.5	3	250	250	105-125	6.0	0.66	Convection	I
SRL 60-8	1	1	1.2	1	3	125	125	105-125	12.5	0.54	Convection	II
SRL 60-17	4	3	2.5	1	3	50	40	105-125	22.0	0.685	Fan	II
SRL 60-35	4	10	5.25	1	3	25	15	190-230	26.0	0.6	Fan	III

NOTES: 1. With load change (NL to FL or FL to NL) and line voltage change (\pm 10% combined), whichever is greater. 2. To return to a bandwidth of \pm 10 mV for a step load change of NL to FL or FL to NL. 3. For 8 hours (after 20 min. warmup) with constant line, load and ambient temperature. 4. Voltage-mode constants are factory selected; they may be altered at rear terminal board. 5. At full compliance voltage. 6. Standard voltage inputs; see "Specifications" for input voltage options.

SRL Series Dimensional Drawings

CASE I (3.5" High)

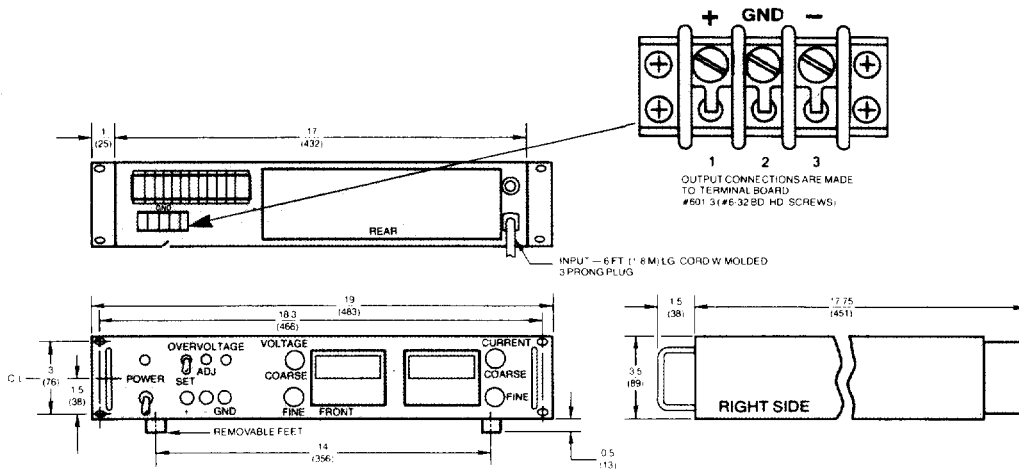

Model	Net Weight		Cooling	Slide Kit Part Number
	lbs.	kg.		
SRL 20-12	45	20.4	Convection	587552-1
SRL 40-6	44	20.0	Convection	587552-1
SRL 60-4	44	20.0	Convection	587552-1

CASE II (5.25" High)

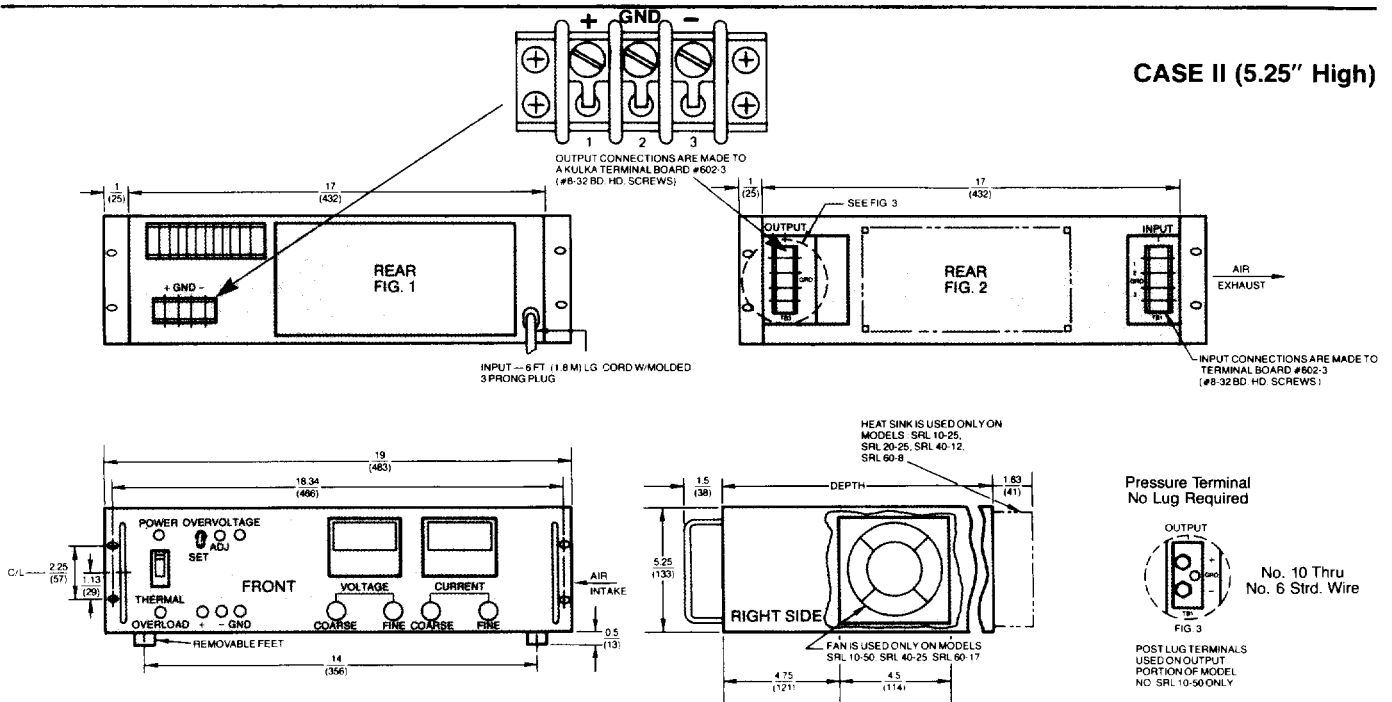

Model	Depth	Rear View	Net Weight		Cooling	Slide Kit Part Number
			lbs.	kg.		
SRL 10-25	16.2 (409)	Fig. 1	64	29	Convection	587552-1
SRL 10-50	21 (533)	Fig. 2	81	36	Fan	N/A
SRL 20-25	16.2 (409)	Fig. 1	64	29	Convection	587552-1
SRL 40-12	16.2 (409)	Fig. 1	64	29	Convection	587552-1
SRL 40-25	21 (533)	Fig. 2	95	43	Fan	N/A
SRL 60-8	16.2 (409)	Fig. 1	64	29	Convection	587552-1
SRL 60-17	21 (533)	Fig. 2	95	43	Fan	N/A

Note: All dimensions are in inches (mm)

SRL Series Dimensional Drawings

CASE III (7" High)

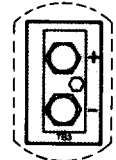
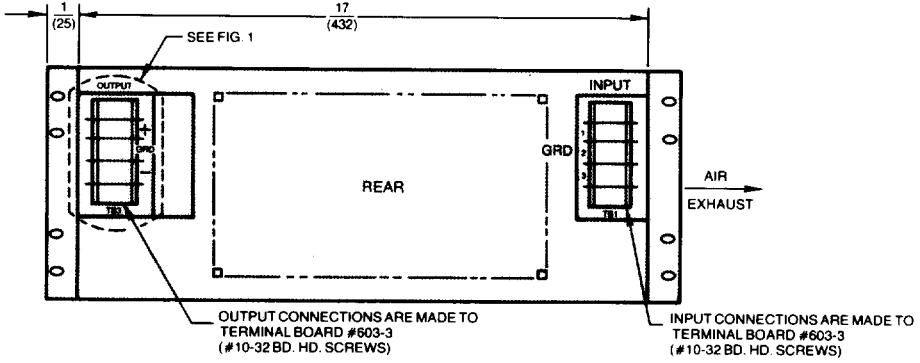
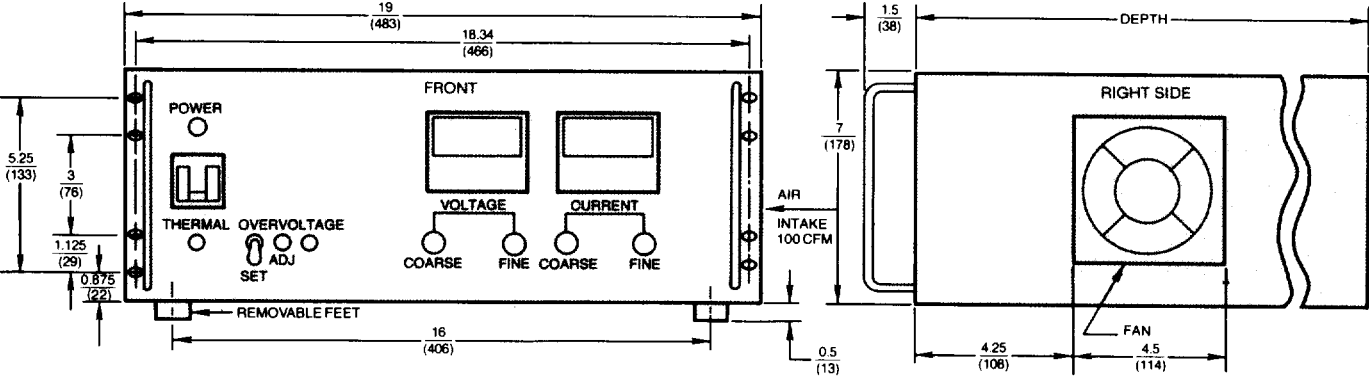

FIG. 1
PRESSURE TERMINALS USED ON OUTPUT PORTION OF MODEL
NO. SRL 10-100 ONLY
NO LUG REQUIRED
ACCEPTS #4 to #6 WIRE



Model	Depth	Weight		Cooling
		lbs.	kg.	
SRL 10-100	23 (584)	132	(60)	Fan
SRL 20-50	21 (533)	128	(58)	Fan
SRL 40-50	21 (533)	120	(54)	Fan
SRL 60-35	21 (533)	120	(54)	Fan

Note: All dimensions are in inches (mm)

SRL Series fully IEEE 488 Programmable

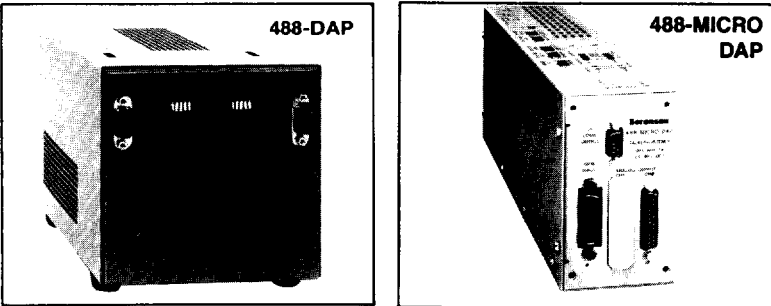

SRL Series is IEEE 488 programmable (and M.A.T.E. qualifiable) with either single or dual channel programmers; see page 61.